



- FR**            **DEVIDOIR SUR ROUES A EQUIPER**  
Manuel d'instructions et d'utilisation
- EN**            **METAL HOSE REEL CART (BARE REEL)**  
User and maintenance manual
- IT**            **AVVOLGITUBO SU RUOTE NON ACCESSORIATO**  
Manuale di istruzioni e di manutenzione
- DE**            **SCHLAUCHABROLLER AUF ROLLEN OHNE AUSSTATTUNG**  
Bedienungs- und Wartungsanleitung
- ES**            **CARRETE PORTAMANGUERAS SOBRE RUEDAS A EQUIPAR**  
Manual de Instrucciones y Mantenimiento

**Réf. / Art. Nr. : PRA/DB.1105 / 734756**









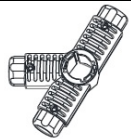
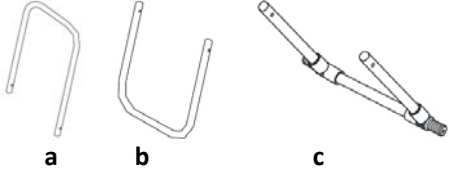

- **Déballage** : Retirez le produit de son emballage. Vérifiez que le produit et les accessoires ne présentent pas de dégâts.
- **Unpacking**: Remove product from its packaging. Check that product and accessories are not damage.
- **Disimballagio**: Rimuovere il prodotto dal suo imballaggio. Controllare che il prodotto e gli accessori non siano danneggiati.
- **Auspacken**: Nehmen Sie das Gerät aus der Verpackung. Gerät und Zubehör auf mögliche Transportschäden überprüfen.
- **Desembalaje**: Saque el producto de su embalaje. Compruebe que el producto y los accesorios no presenten daños.

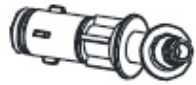

L'utilisation de ce produit est interdite aux enfants et adolescents.  
 The use of this product by children is forbidden.  
 L'utilizzo di questo prodotto è vietato ai bambini ed adolescenti.  
 Das Gerät darf nicht von Kindern benutzt werden.  
 Se prohíbe el uso del producto por niños.

### Contenu / Content / Contenido / Standard-Ausrüstung / Contenido

Pc	Desc.	Qt	
1	Support lateral / Support Stand / Supporto laterale / Standfuß / Soporte lateral	2	
2	Poignée et pieds métal / Metal Handle & feet / Manico e piedi metal / Metallhandgriff und Fallstützen vorn und hinten / Manija y pies en metal	1+1+1	
3	Dévidoir / Reel / Avvolgitore / Spule platte / Carcassa del carrete	2	
4	Porte tuyau / Reel cross bar / Supporto per tubo / Schlauchhalter / Soporte de manguera	2	
5	Manivelle / Crank handle / Manovella / Handkurbel / Manivela	1	
6	Connecteur tuyau / Elbow hose connector set / Connettore per tubo / Schlauchverbinder / Conector para manguera	1	
7	Adaptateur femelle / Female adaptor / Adattatore donna / Kupplung mit Innengewinde/ Adaptador hembra	1	
8	Cheville / Nail Pin / Chiodi / Schraube / Pasador	6	
9	Roue / Wheels / Ruota / Rad / Rueda	2	
10	Enjoliveur / Wheel cap / Copertura di ruota / Radkappe / Cubierta de rueda	2	

Assemblage / Assembly / Installazione / Montage / Instalación

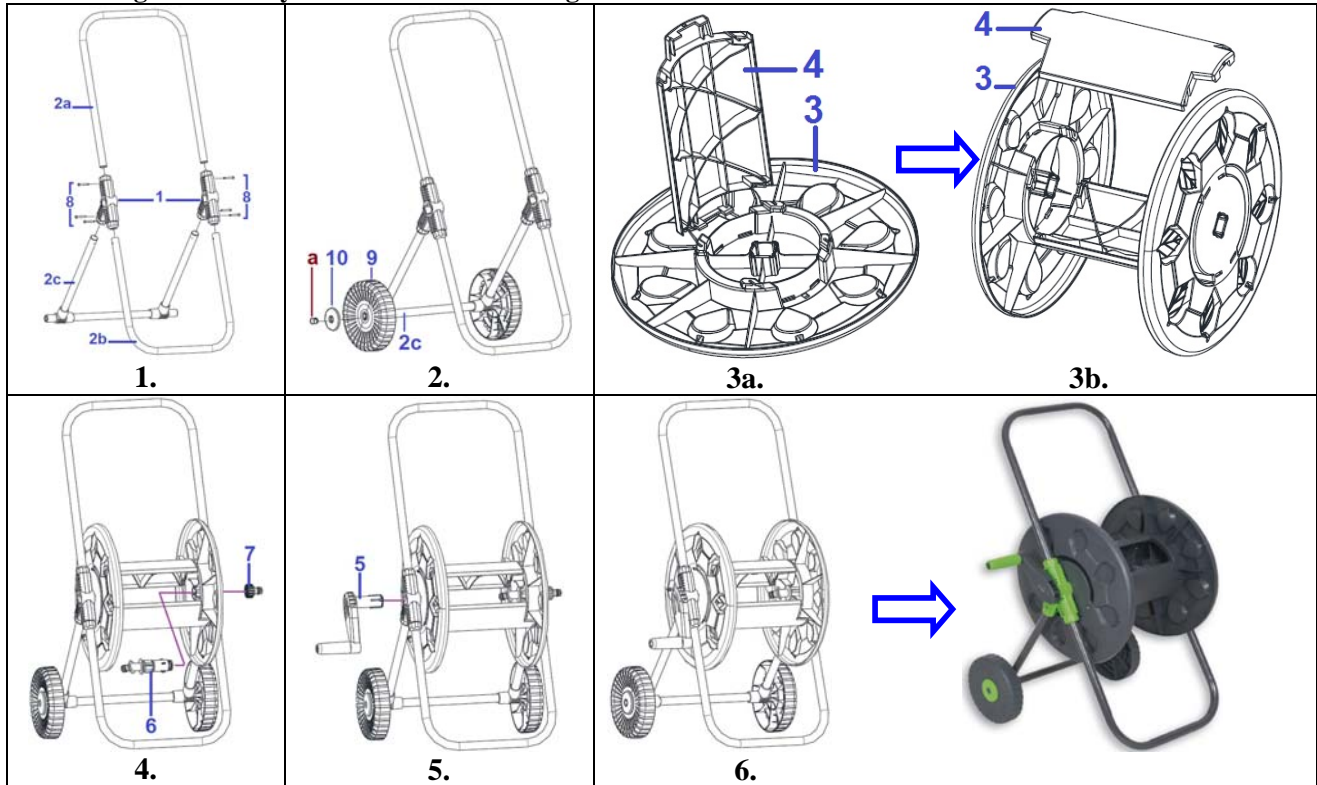

Capacité tuyau / Hose capacity / Capacità tubo / Schlauchkapazität / Capacidad para manguera:

**12,5 mm**  
**Ø 1/2"**  
**= 60 m**



**15 mm**  
**Ø 5/8"**  
**= 40 m**



**19 mm**  
**Ø 3/4"**  
**= 30 m**

